



03

COMPONENTES PARA COZINHA
COMPONENTS FOR KITCHEN
COMPOSANTS POUR CUISINE





GAVETAS E CORREDIÇAS

DRAWERS AND SLIDES

TIROIRS ET GLISSIÈRES



REF **CB01**

COMPIMENTO NOMINAL
NOMINAL LENGTH
LONGUEUR NOMINALE

300	450
350	500
400	550

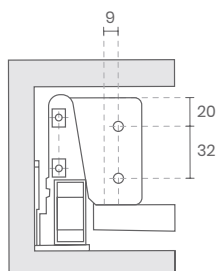

■ ACABAMENTOS FINISHING

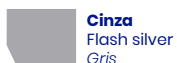

REF **CB01**



COMPIMENTO NOMINAL
NOMINAL LENGTH
LONGUEUR NOMINALE

300	450
350	500
400	550

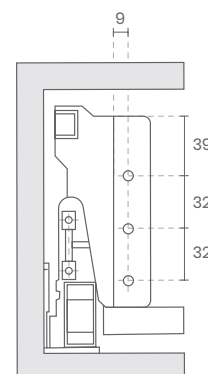

■ ACABAMENTOS FINISHING



REF **CB2**



REF **PAR VARETAS CB01**





REF **CB01**



EXTRAÇÃO TOTAL
FULL-EXTENSION
EXTRACTION TOTALE

C/AMORTECEDOR
SOFT CLOSING
SOFT CLOSING

COMPIMENTO NOMINAL
NOMINAL LENGTH
LONGUEUR NOMINALE

300	450
350	500
400	550

■ ACABAMENTOS FINISHING

Branco
White
Blanc

Cinza
Flash silver
Gris

REF **2 PARES VARETAS CB02**



REF **CB3**

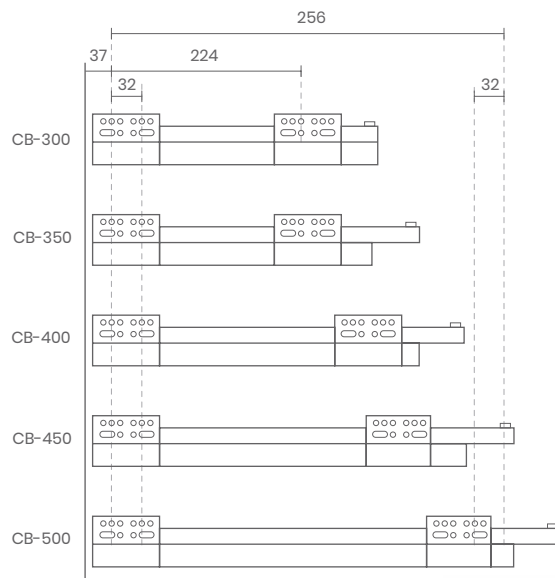
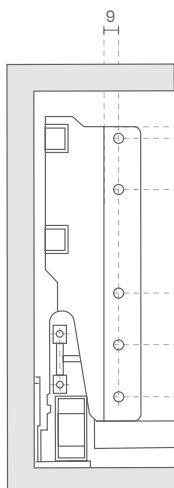

REF **CB5** (1 METRO)REF **CB4** (1 METRO)

■ CONECTORES FRONTAIS

REF **CB83**REF **CB142**REF **CB200**

SLIM

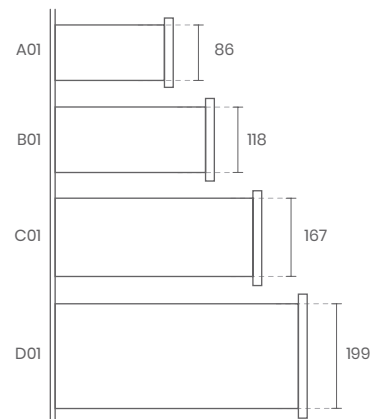

REF.	COMPRIMENTO NOMINAL NOMINAL LENGTH LONGUEUR NOMINALE	
SLIM A01	300	450
SLIM B01	350	500
SLIM C01	400	
SLIM D01		

■ ACABAMENTOS FINISHING

Branco
White
Blanc

Cinza antracite
Flash silver
Gris

REF **4513**

COMPRIMENTO NOMINAL
NOMINAL LENGTH
LONGUEUR NOMINALE

45KG	200	500
	300	550
	350	600
	400	650
	450	700

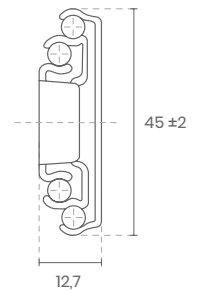

EXTRAÇÃO TOTAL
FULL-EXTENSION
EXTRACTION TOTALE

CORREDEIRA DE ESFERAS
BALL SLIDE
GLISSIÈRE À BILLES

REF **E46**



COMPIMENTO NOMINAL
NOMINAL LENGTH
LONGUEUR NOMINALE

36KG	300	500
	350	550
	400	600
	450	

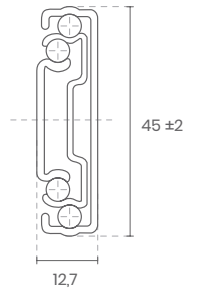

EXTRAÇÃO TOTAL
FULL-EXTENSION
EXTRACTION TOTALE

TIC-TAC
PUSH TO OPEN
APPUYER POUR OUVRIR

REF **E47**



COMPIMENTO NOMINAL
NOMINAL LENGTH
LONGUEUR NOMINALE

36KG	300	500
	350	550
	400	600
	450	650

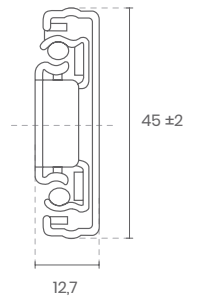

EXTRAÇÃO TOTAL
FULL-EXTENSION
EXTRACTION TOTALE

C/AMORTECEDOR
SOFT CLOSING
SOFT CLOSING

REF **R683**



25KG

■ ACABAMENTOS FINISHING



OPÇÃO
OPTION
OPTION

SALICE

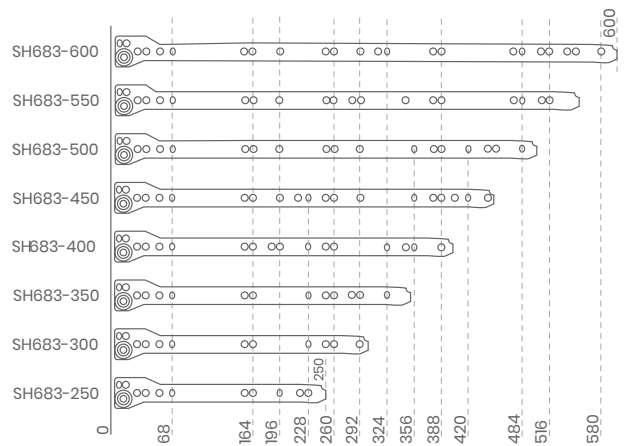

REF **N3F2**



COMPIMENTO NOMINAL
NOMINAL LENGTH
LONGUEUR NOMINALE

35KG

250	450
300	500
350	550
400	

OPÇÃO CORREDIÇAS SLIDES OPTION OPTION GLISSIÈRES

DTC

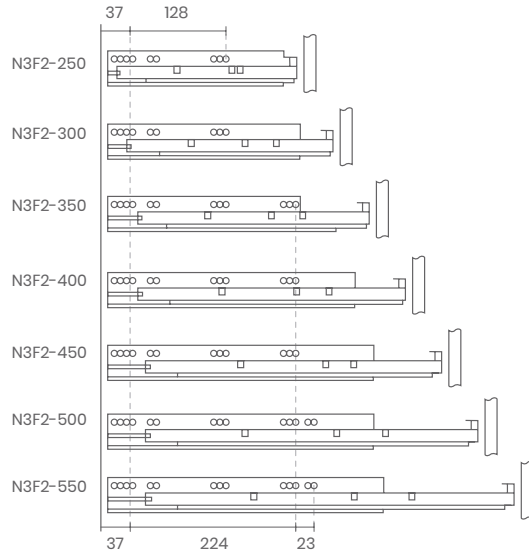

EXTRAÇÃO TOTAL
FULL-EXTENSION
EXTRACTION TOTALE

C/AMORTECEDOR
SOFT CLOSING
SOFT CLOSING

REF **N2F2**



COMPIMENTO NOMINAL
NOMINAL LENGTH
LONGUEUR NOMINALE

25KG

250	450
300	500
350	550
400	

OPÇÃO CORREDIÇAS SLIDES OPTION OPTION GLISSIÈRES

DTC

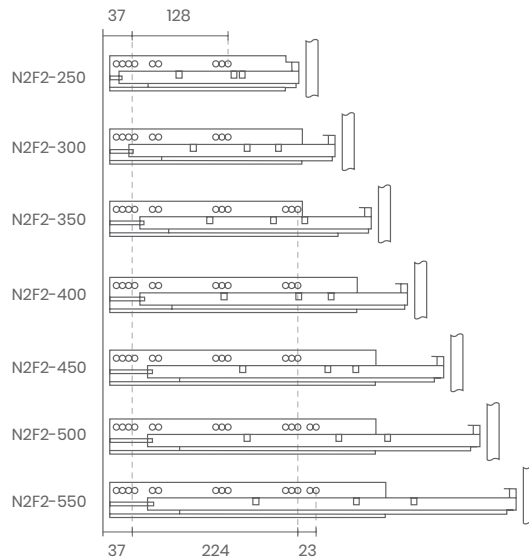

EXTRAÇÃO PARCIAL
PARTIAL EXTENSION
EXTRACTION PARTIELLE

C/AMORTECEDOR
SOFT CLOSING
SOFT CLOSING



CANTOS MÁGICOS E CESTOS

MAGICAL CORNERS AND BASKETS

CONINS MAGIQUES ET PANIERS



REF **PORTA GARRAFAS INOXA**

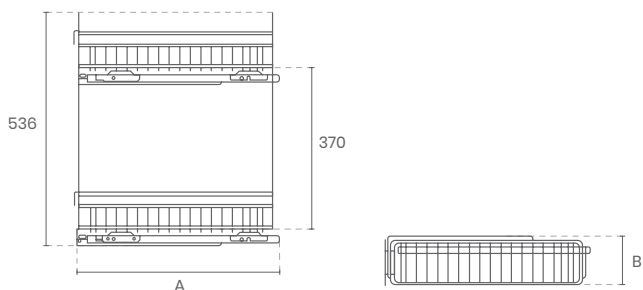

REF.	B (mm)	A (mm)
15x50	109	
 20x50	156	280
25x50	206	472

CORREDIÇAS
SLIDES
GLISSIER



REF **PORTA GARRAFAS**

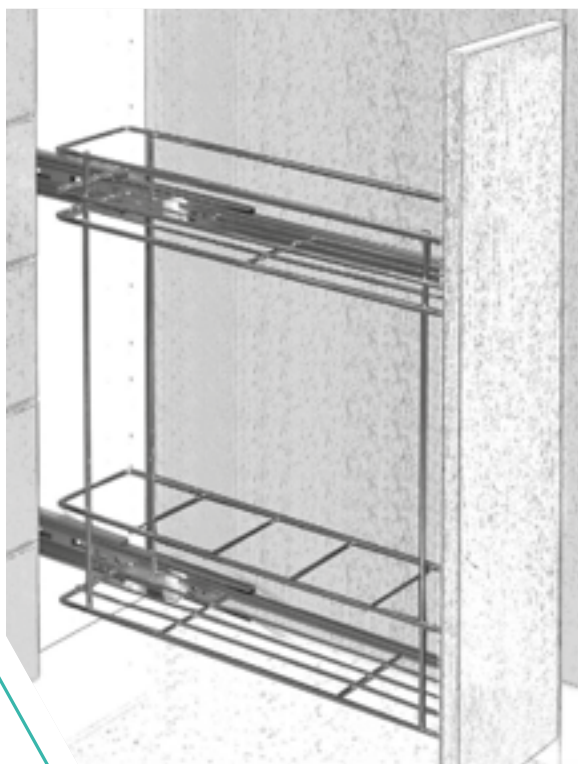

MOD.

15

20

30



REF \ **PORTA GARRAFAS INOXA**

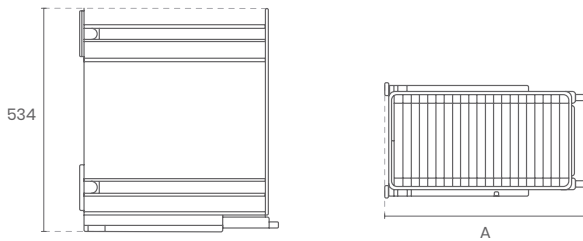

REF.	B (mm)	A (mm)
 30x50	264	477
40x50	364	

CORREDIÇAS
SLIDES
GLISSIER

 Hettich

 SALICE



REF \ **PORTA GARRAFAS PÃO CRM**

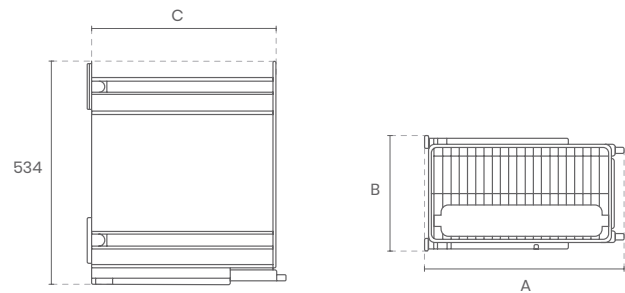

REF.	B (mm)	A (mm)	C (mm)
CRM x30	264	477	444
 CRM x35	314		
CRM x40	364		
CRM x45	414		

CORREDIÇAS
SLIDES
GLISSIER

 Hettich

 SALICE



REF ESTRUTURA P/DISPENSEIRO

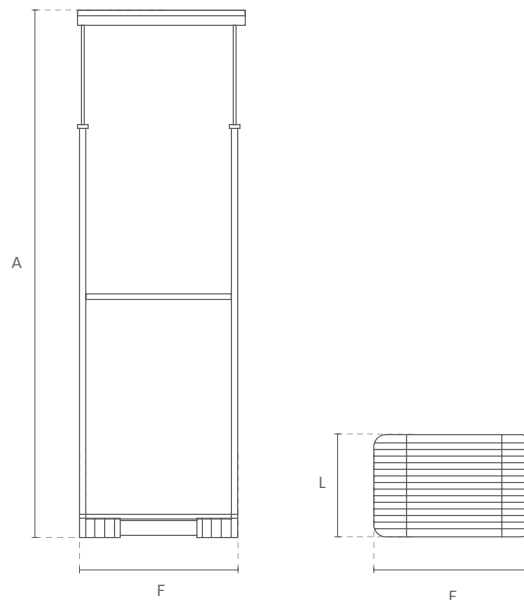

	MOD.	L (mm)	F (mm)	A (mm)
ALTO HIGH GRAND	300	250	500	1825 2185
	400	350		
	450	400		
	600	550		
MÉDIO MEDIUM MOYEN	300	250	500	1480 1860
	400	350		
	450	400		
	600	550		
PEQUENO LOW PETIT	300	250	500	1135 1495
	400	350		
	450	400		
	600	550		



REF CESTOS PARA DISPENSEIRO



REF.	L (mm)	F (mm)
30/50	300	500
40/50	400	
45/50	450	
60/50	600	



REF **CESTO MULTIUSOS**

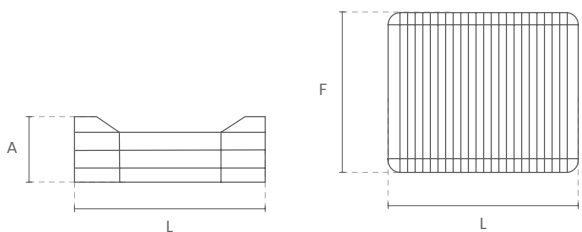

MOD.	L (mm)	F (mm)	A (mm)
300	264		
350	314		
400	364		
450	414		
500	464	450	170
600	564		
800	764		
900	864		



CORREDIÇAS
SLIDES
GLISSIER



REF **DINAMIC**



DIREITO

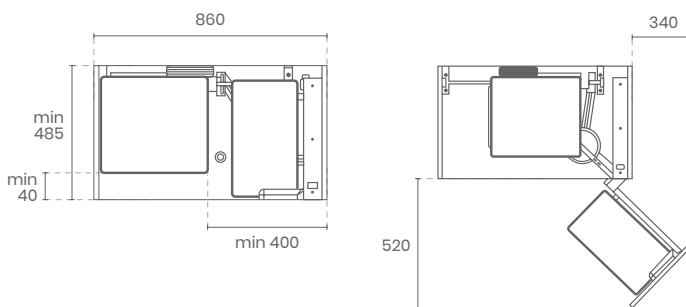

ESQUERDO

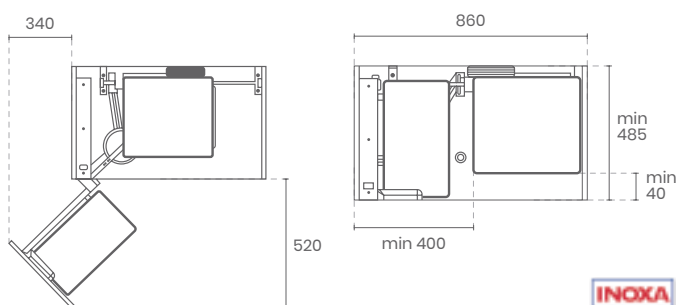



REF \ CANTO FEIJÃO

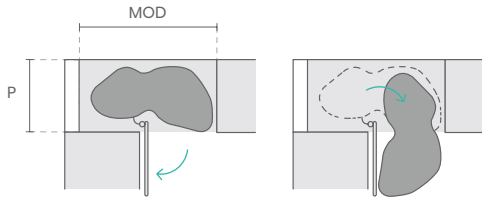

REF \ 4210 DIREITO

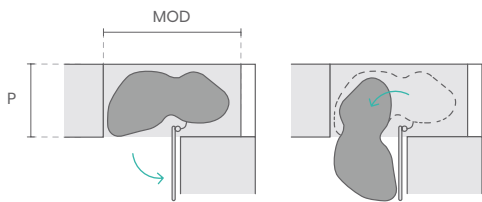

REF \ 4209 ESQUERDO

MOD.	L (mm)	P (mm)	C/ BANDEJA ANTIDERRAPANTE
900	865	495	

OPÇÃO
OPTION
OPTION



REF \ CESTO GIRATÓRIO 2/4

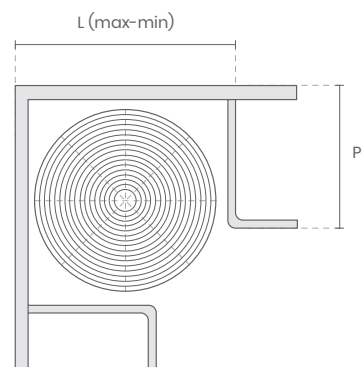

MOD.	Ø (mm)	L (mm)	P (mm)	
	460	500	465	
	510	560-600	525	
600-900	610	660-700	625	360°
	710	760-800	725	
	810	860-900	825	

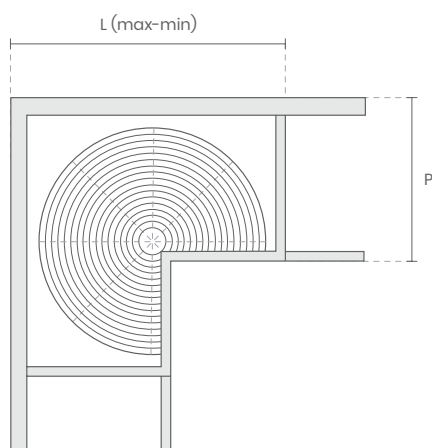
REF **CESTO GIRATÓRIO 3/4**

MOD. (mm)	Ø (mm)	L (mm)	P (mm)	
600-900	720	800-600	760	270°
	820	900-600	860	

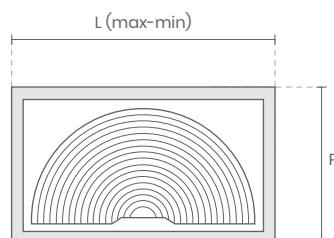
REF **CESTO GIRATÓRIO 2/4**

MOD. (mm)	Ø (mm)	L (mm)	P (mm)	
600-900	660	750	700	180°
	740	800	750	
	845	900	850	

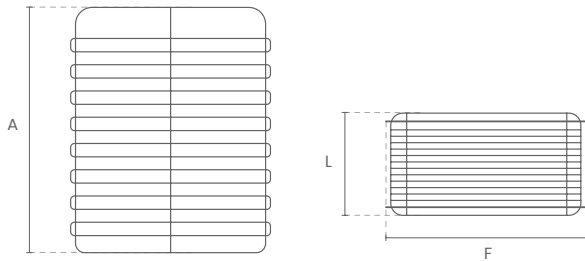
REF **TULHA**

MOD.	L (mm)	F (mm)	A (mm)
300	250		
350	300		
400	350		
450	400	270	400/500
500	450		
600	550		

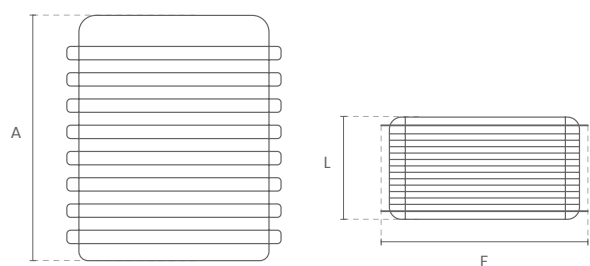
REF **TULHA EXTENSÍVEL**

MOD.	L (mm)	F (mm)	A (mm)
300	230		
400	320		
450	380	470	550
600	540		





BALDES DO LIXO

TRASH CANS

POUBELLES



REF \ **ECOLÓGICO 600**

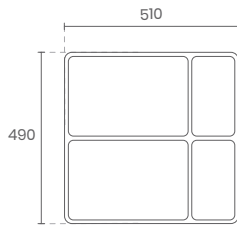

ellelapi

REF \ **ECOLÓGICO 800**

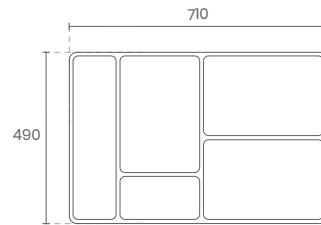

ellelapi

REF \ **ECOLÓGICO 900**

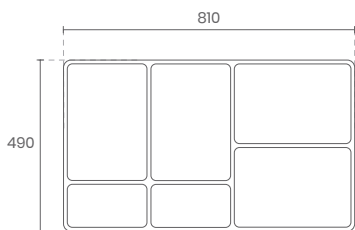

ellelapi

REF \ **ECOLÓGICO 1200**

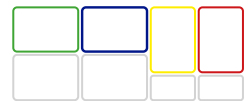
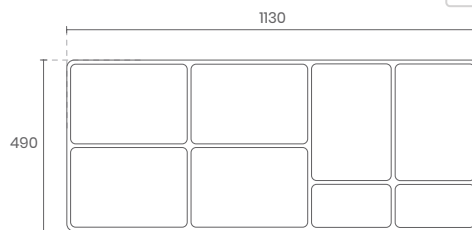

ellelapi



REF \ **620 X1**

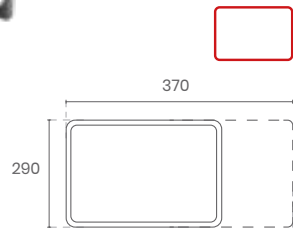

REF \ **720 X2**

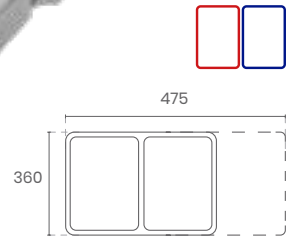

REF \ **820 X3**

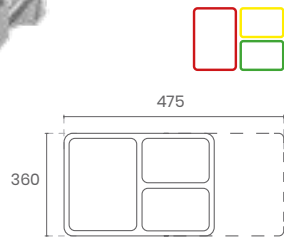

REF \ **2720**

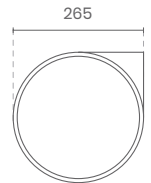

REF \ **HAILO**

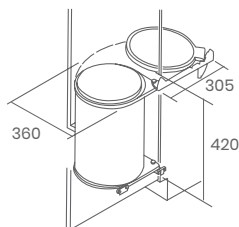



PERFIS
PROFILES
PROFILS

REF / 1278

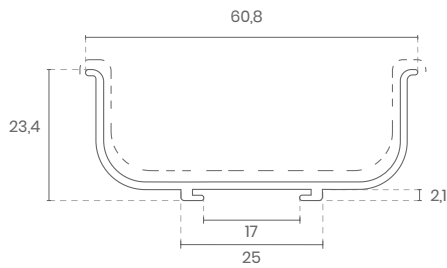
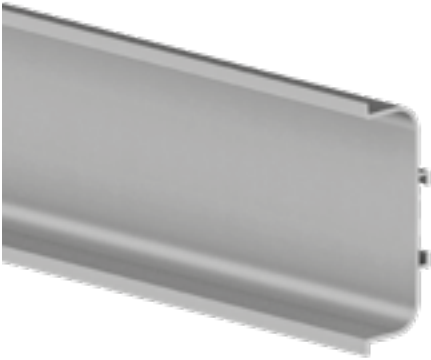

REF / 1279

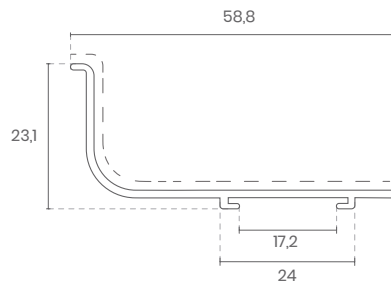
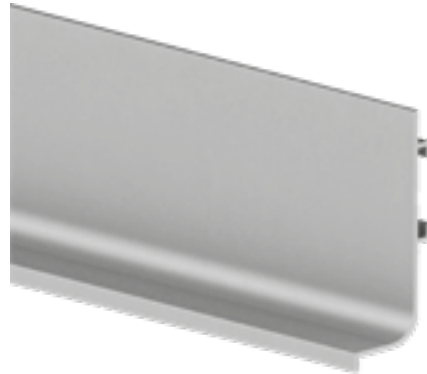

■ ACABAMENTOS FINISHING



Lacado Branco
White lacquer
Laquée blanc



Cromado mate
Matt chrome
Chrome mate



Inox
Stainless steel
Acier inoxydable

REF / 1279 MINI

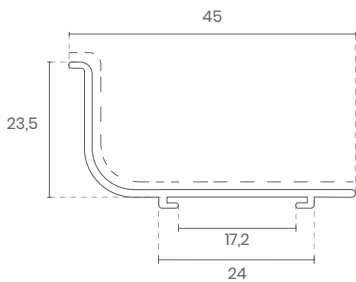
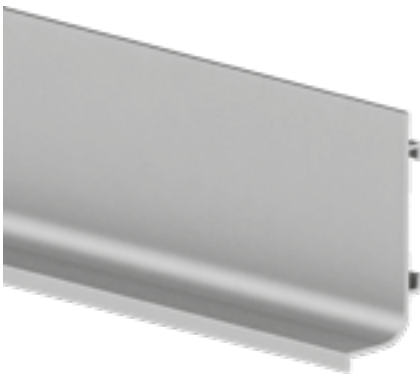

REF / K108

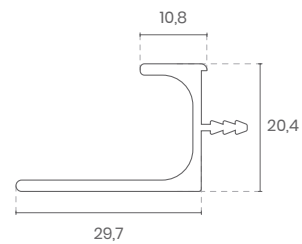
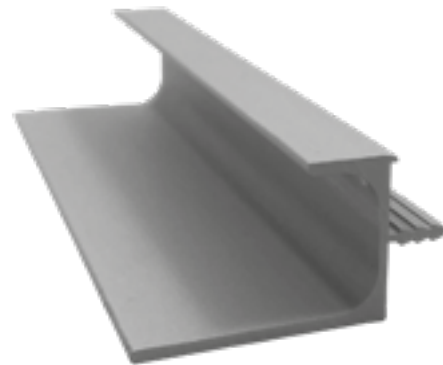

■ ACABAMENTOS FINISHING



Lacado Branco
White lacquer
Laquée blanc



Cromado mate
Matt chrome
Chrome mate



Inox
Stainless steel
Acier inoxydable

REF / **PERFIL VITRINE A** COM REFORÇO

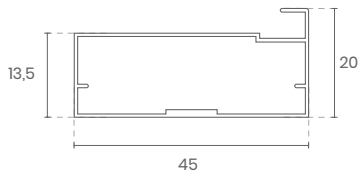
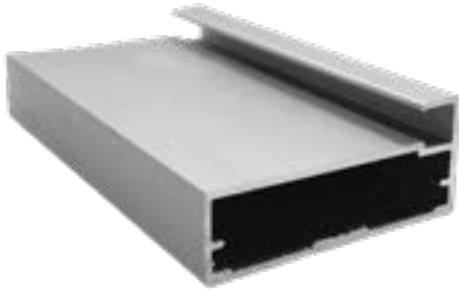

REF / **PERFIL VITRINE B**

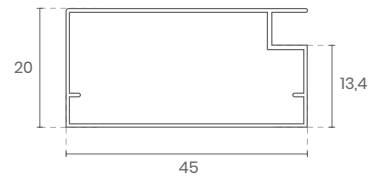

REF / **PERFIL RODAPÉ**

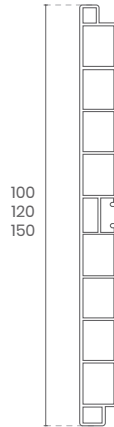

OPÇÃO
OPTION
OPTION



■ ACABAMENTOS FINISHING

Branco
White
Blanc

Alumínio
Aluminum
Aluminium

REF / **C. FLEXÍVEL 363**

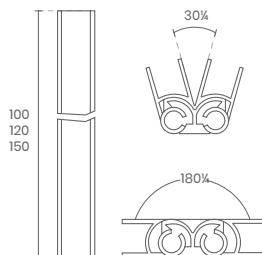

REF / **CANTO 663**

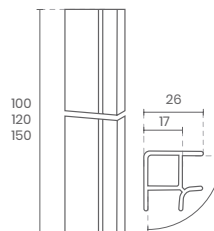

REF / **UNIÃO 963**

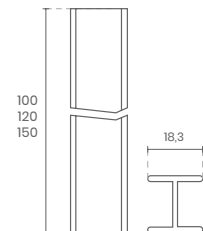



FUNDOS E PORTA TALHERES

BOTTOMS AND CUTLERY HOLDER

FONDS ET PORTE-COUVETS



REF

FUNDO ALUMÍNIO

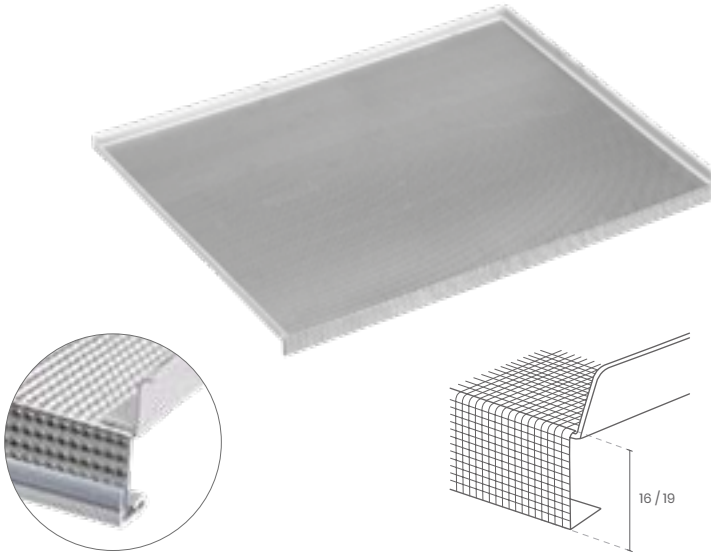

COMPRIMENTO
LENGTH
LONGUEUR

500	900
600	1000
700	1100
800	1200

■ ACABAMENTOS FINISHING

Alumínio
Aluminum
Aluminium



REF

PORTA TALHERES



REF.

COMPRIMENTO NOMINAL
NOMINAL LENGTH
LONGUEUR NOMINALE

	300	700
	350	800
	400	900
METABOX	450	1000
	500	1100
	550	1200
	600	

■ ACABAMENTOS FINISHING

Branco
White
Blanc

Cinza
Flash silver
Gris



LAVA LOIÇAS
DISHWASHER
LAVE-VAISSELLE



REF **E37001**



■ PROFUNDIDADE DA PIA BOWL DEPTH - 190MM

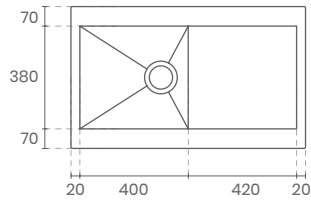

REF **E37003**



■ PROFUNDIDADE DA PIA BOWL DEPTH - 190MM

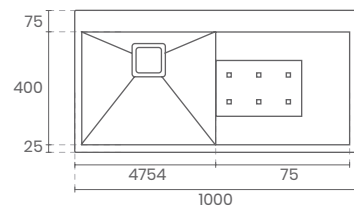

REF **E42082**



■ PROFUNDIDADE DA PIA BOWL DEPTH - 160MM

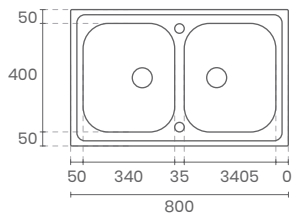

REF **E42100**



■ PROFUNDIDADE DA PIA BOWL DEPTH - 160MM

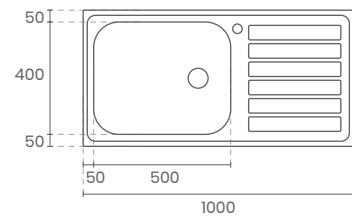

REF **E6045**



■ PROFUNDIDADE DA PIA BOWL DEPTH - 150MM

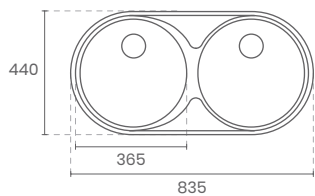

REF **E7045**

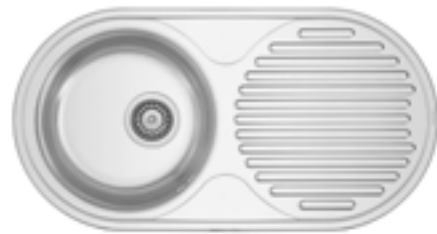

■ PROFUNDIDADE DA PIA BOWL DEPTH - 150MM

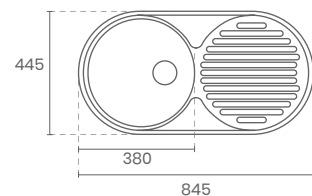

REF **E42080**



■ PROFUNDIDADE DA PIA BOWL DEPTH - 160MM

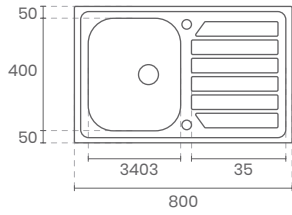

REF **E18001**

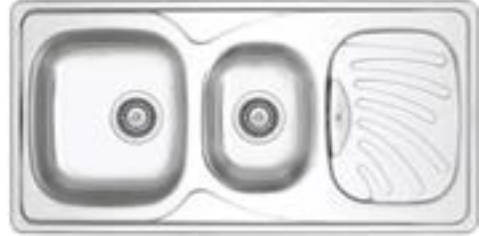

■ PROFUNDIDADE DA PIA BOWL DEPTH - 150MM

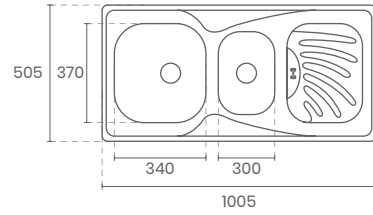

REF **E42102**



■ PROFUNDIDADE DA PIA BOWL DEPTH - 150/160MM

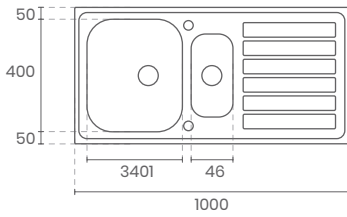

REF **E26001**



■ PROFUNDIDADE DA PIA BOWL DEPTH - 160MM

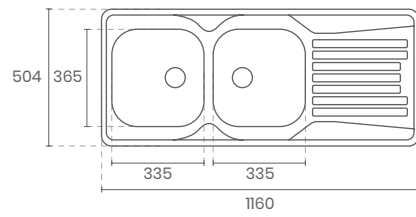

REF **E42120**



■ PROFUNDIDADE DA PIA BOWL DEPTH - 160MM

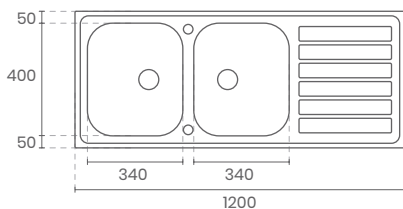

REF **U30001**



■ PROFUNDIDADE DA PIA BOWL DEPTH - 160/180/200MM

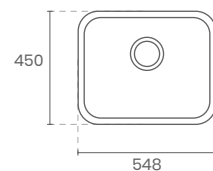



ASAS
PROFILES
PROFILS

REF \ 24

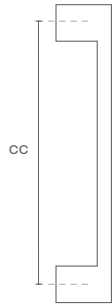

cc (mm)

96	160
128	190

■ ACABAMENTOS FINISHING

 **Niquelado escovado**
Brushed Nickel
Nickelê brossê

REF \ 172 AL

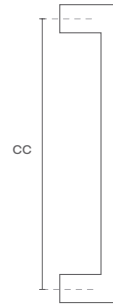

cc (mm)

128	190
160	224

■ ACABAMENTOS FINISHING

 **Niquelado escovado**
Brushed Nickel
Nickelê brossê

 **Alumínio**
Aluminum
Aluminium

REF \ Q106

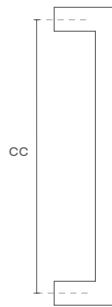

cc (mm)

128	224
160	320

■ ACABAMENTOS FINISHING

 **Niquelado escovado**
Brushed Nickel
Nickelê brossê

REF \ 01X10



cc (mm)

96	320
128	352
160	384
192	448
224	480
242	512
256	586
288	

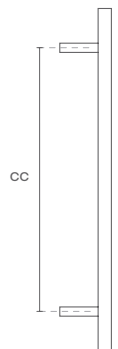

■ ACABAMENTOS FINISHING

 **Inox**
Stainless steel
Acier inoxydable

REF \ **8014**

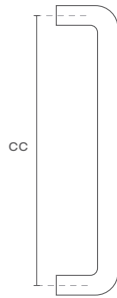

cc (mm)

96	160
128	

■ ACABAMENTOS FINISHING

Inox
Stainless steel
Acier inoxydable

REF \ **Q100**

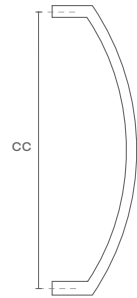

cc (mm)

128	190
160	224

■ ACABAMENTOS FINISHING

Niquelado escovado
Brushed Nickel
Nickelê brossé

REF \ **1604**

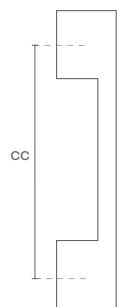

cc (mm)

160	224
192	

■ ACABAMENTOS FINISHING

Niquelado escovado
Brushed Nickel
Nickelê brossé

Alumínio
Aluminum
Aluminium

REF \ **Q046**

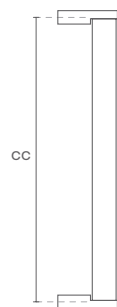

cc (mm)

128	192
160	224
320	

■ ACABAMENTOS FINISHING

Inox
Stainless steel
Acier inoxydable

REF \ **091**

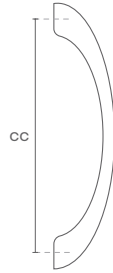

cc (mm)

160	224
192	

■ ACABAMENTOS FINISHING

-  **Cromado mate**
Matt chrome
Chrome mate
-  **Bronze**
Bronze
Bronze

REF \ **14F**



cc (mm)

96	128
----	-----

■ ACABAMENTOS FINISHING

-  **Alumínio**
Aluminium
Aluminium
-  **Bruto**
Gross
Grossier

REF \ **1536** X25

\ **1536** X30



■ ACABAMENTOS FINISHING

-  **Niquelado escovado**
Brushed Nickel
Nickelé brossé
-  **Bronze**
Bronze
Bronze

REF \ **08Q**

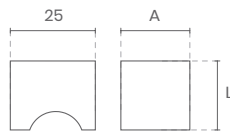

A (mm) L (mm)

15	15
18	18
20	20

■ ACABAMENTOS FINISHING

-  **Inox**
Stainless steel
Acier inoxydable

REF \ **08**

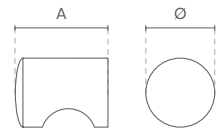

A (mm) Ø (mm)

19	12
22	15
24	18
25	20
30	25

■ ACABAMENTOS FINISHING

-  **Inox**
Stainless steel
Acier inoxydable



DOBRADIÇAS

HINGES

CHARNIÈRES

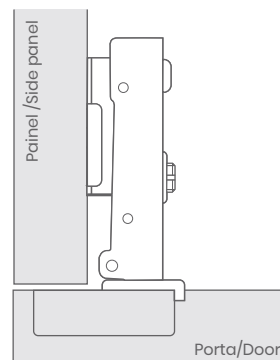
REF **F07**REF **F07A**

■ INFORMAÇÕES INFORMATION

Com amortecedor / Soft close
 Opção calço 3D
 Opção calço 2D

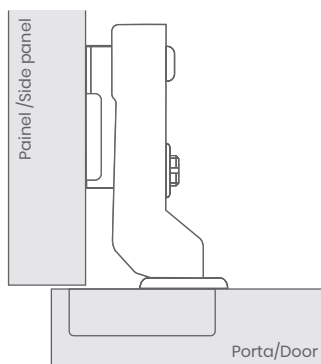
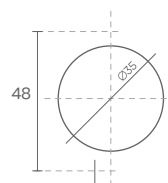
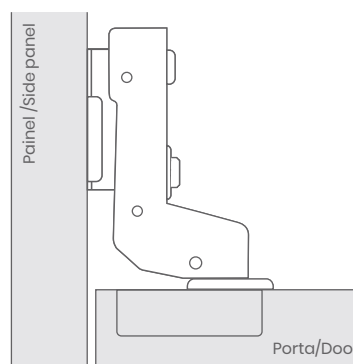
REF **F07B**REF **F07C**

CALÇO 3D
 3D SHIM
 CALE 3D

CALÇO NORMAL 2D
 NORMAL 2D SHIM
 CALE NORMALE 2D

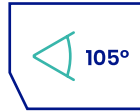
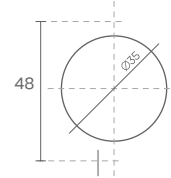
REF **F06**

■ INFORMAÇÕES INFORMATION

Com amortecedor / Soft close
Opção calço 3D

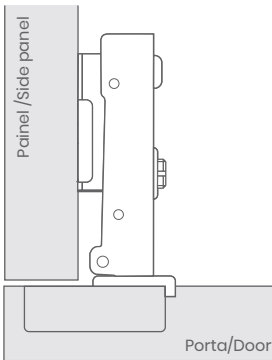
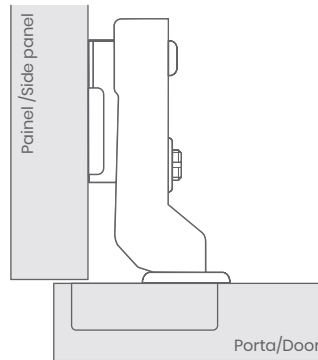
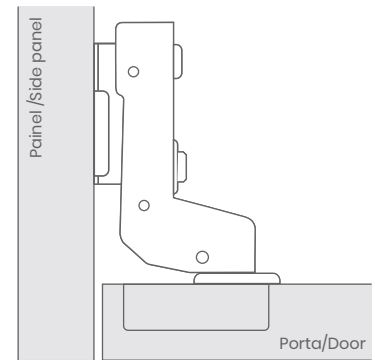
REF **F06A**REF **F06B**REF **F06C**

REF / **S83A**

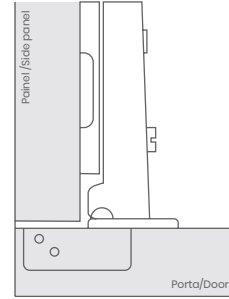

■ INFORMAÇÕES INFORMATION

Sem amortecedor
Calço 2D - embutir

REF / **S83B**

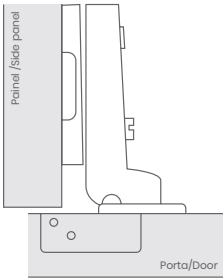

REF / **S83C**

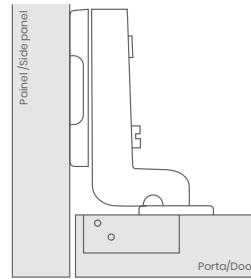

REF / **J2**



CALÇO NORMAL
NORMAL SHIM
CALE NORMALE

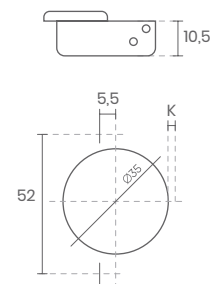

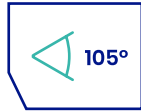

REF **S85A**

REF **S85B**

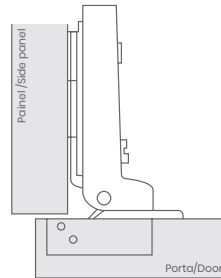
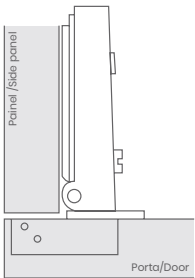

■ **INFORMAÇÕES INFORMATION**

Sem amortecedor
Calço 2D c/clic



CALÇO NORMAL
NORMAL SHIM
CALE NORMALE

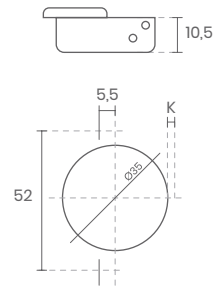

REF **R CURTO**

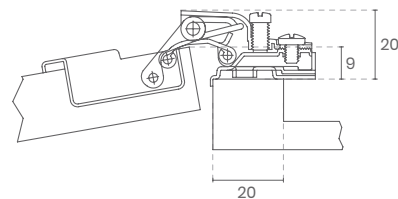
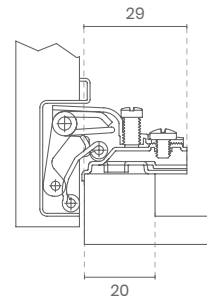

DOBRADIÇA COPO 26° 26° GLASS HINGE CHARNIÈRE EN VERRE 26°

REF \ **RECTA**

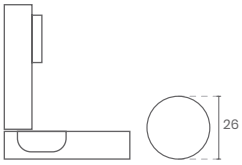

REF \ **C/8**

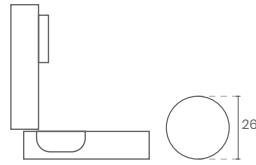

REF \ **C/TOTAL**

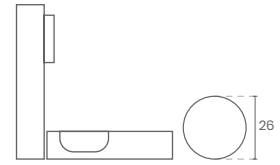

CALÇO NORMAL
NORMAL SHIM
CALE NORMALE

REF \ **90°**

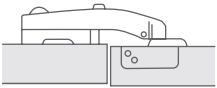

REF \ **135°**

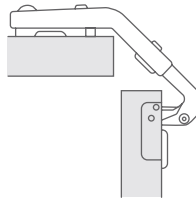

REF \ **180° - 165°**

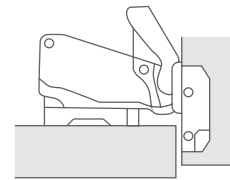

CALÇO NORMAL
NORMAL SHIM
CALE NORMALE

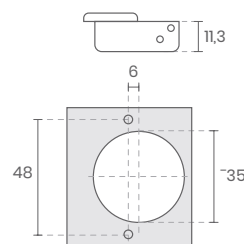



PRODUTOS COMPLEMENTARES DE COZINHA

COMPLEMENTARY KITCHEN PRODUCTS

PRODUITS DE CUISINE COMPLÉMENTAIRES

REF.

200001



MEDIDAS MEASURES MESURES
X100 / X120 / X150



X1X



MEDIDAS MEASURES MESURES
X100 / X120 / X150



40X1



MEDIDAS MEASURES MESURES
X100 / X120 / X150



**59528/
59538**

MEDIDAS MEASURES MESURES
59528 X150 / 59538 X100



REF.

59426
GRAMPA PLÁSTICO



59423
GRAMPA MADEIRA

702



P11

MEDIDAS MEASURES MESURES
X100 / X120 / X150













P11
GRAMPA



97ABC



REF.	REF.
<p>202</p> 	<p>1010</p> 
<p>F084 X 4 FUROS</p> 	<p>ESQUADRO 127CL</p> 
<p>402</p> 	<p>1011</p> 
<p>209</p> 	<p>K39</p> 
<p>210</p> 	<p>K59</p> 
<p>212</p> 	

REF.

REF.

701



NIVELADOR



TAMPA
701



COMPASSO
SH106



MEDIDAS MEASURES MESURES
60N / 80N / 100N / 120N / 150N

REF 201



REF 199 8 ELEMENTOS

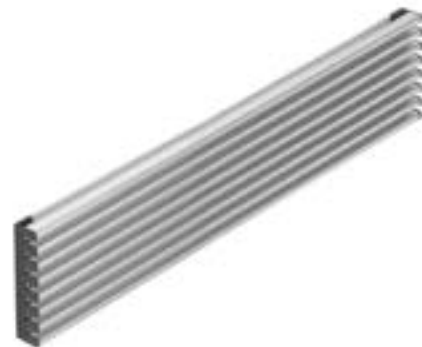

REF.

MEDIDAS
MEASURES
MESURES



Cromado mate
Matt chrome
Chrome mate



Branco
White
Blanc

201 G

445x70

201 P

221x70

MEDIDAS
MEASURES
MESURES



Inox
Stainless steel
Acier inoxydable



Cromado mate
Matt chrome
Chrome mate



Branco
White
Blanc

125x60

125x90

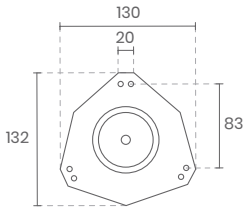
REF / **PÉ MESA**

MEDIDAS MEASURES MESURES
80X710 / 80X830 / 80X870

■ **ACABAMENTOS FINISHING**

Nickel satinado
Satin nickel
Nickelé satiné

REF / **FREE MINI**

REF.	DESCRIÇÃO DESCRIPTION DESCRIPTION	ALTURA HEIGHT TAILLE	
0300520	mini A	200/400	0,8/3,8
0300620	mini B	200/400	1,7/6,4
0300720	mini C	200/400	3,2/11,8

 **KESSEBÖHMER**

REF / **FREE FORTE**

REF.	DESCRIÇÃO DESCRIPTION DESCRIPTION	ALTURA HEIGHT TAILLE	
0300820	forte D	350/650	3,0/9,6
0300920	forte E	350/650	3,8/12,4
0301020	forte F	350/650	5,7/18,6
0301120	forte G	350/650	7,6/23,6

 **KESSEBÖHMER**

REF / **COMPASSO DE MICROONDAS**

REF.	MEDIDAS MEASURES MESURES	
0301720	600	
0301820	900	01
0301920	1200	

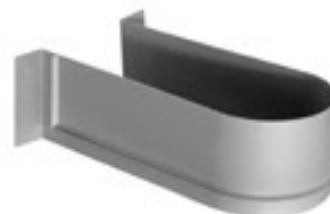
REF / **SALVA SIFÃO**REF / **3T** TOMADA DE BANCADA